

# **DTSU666-H and DTSU666-H 250 A/50mA Smart Power Sensor Quick Guide**

Issue: 03  
Date: 2019-09-29

**HUAWEI TECHNOLOGIES CO., LTD.**



# 1 Overview

## Models

- DTSU666-H: with three 100 A/40 mA CT
- DTSU666-H 250 A/50 mA: with three 250 A/50 mA CT

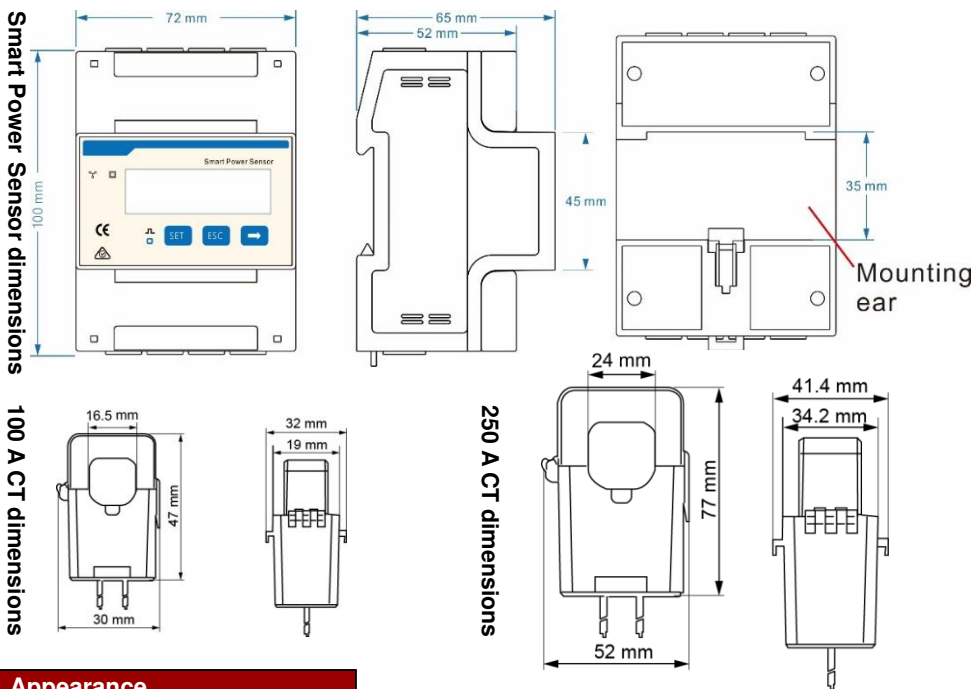

## Appearance

Differences between DTSU666-H and DTSU666-H 250 A/50 mA:

- Parameters on the panel

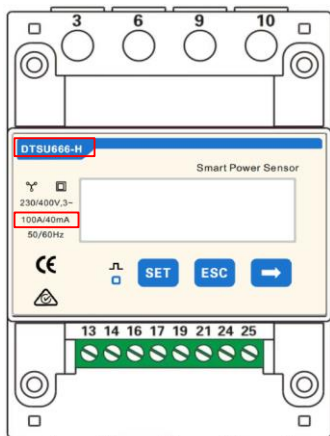

DTSU666-H

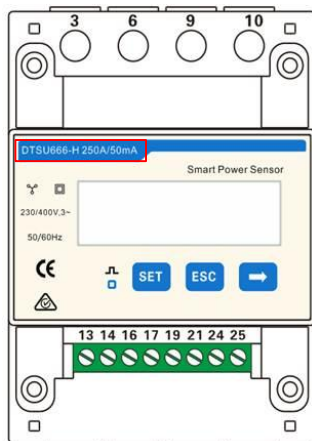

DTSU666-H 250 A/50 mA

## Appearance

- Nameplate

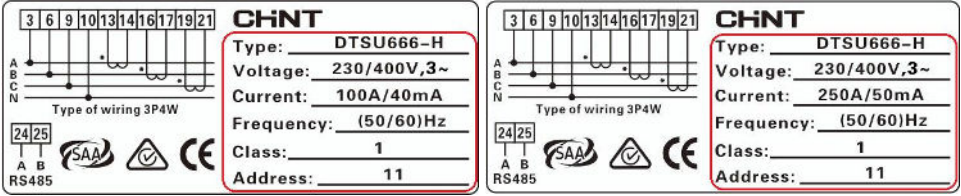

DTSU666-H

DTSU666-H 250 A/50 mA

## Performance and Specification

Category	DTSU666-H	DTSU666-H 250 A/50 mA
Nominal voltage	230 V AC / 400 V AC	230 V AC / 400 V AC
Current Measurement range	0–100 A	0–250 A
Power grid system	3P4W	3P4W or 3P3W

## Port Definition

Voltage Input:  $3 \times 230/400$  V or  $3 \times 400$  V

Current Transformer(CT): 100 A/40 mA or 250 A/50 mA;

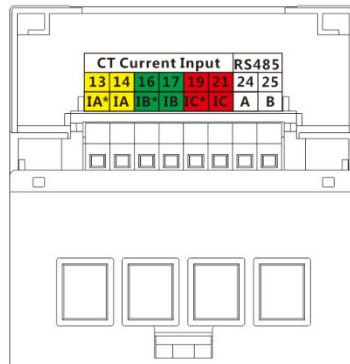
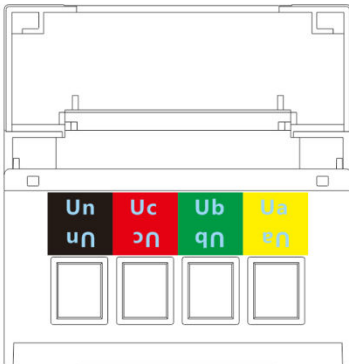

## 2 Installing the DTSU666-H and DTSU666-H 250 A/50 mA

1. Install the smart power sensor on the standard din rail of DIN35mm
2. Install the Smart Power Sensor to the standard din rail from the top to the bottom, and then push the instrument to the din rail from the bottom to the front part.

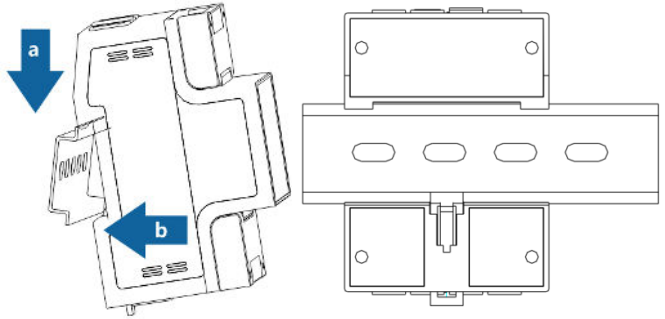

## 3 Installing the Cable

### Prepare cables

Cable	Port	Type	Conductor Cross-sectional Area Range	Outer Diameter	Source
AC power cable	Ua-3	Four-core outdoor copper cable	4-6 mm <sup>2</sup>	10-21 mm	Prepared by the customer
	Ub-6				
	Uc-9				
	Un-10				
CT cable	IA*-13	/	/	/	Manufacturer
	IA-14	/	/	/	
	IB*-16	/	/	/	
	IB-17	/	/	/	
	IC*-19	/	/	/	
	IC-21	/	/	/	
Comm. cable	RS485A-24	Two-core outdoor shielded twisted pair	0.25-1 mm <sup>2</sup>	4-11 mm	Manufacturer
	RS485B-25				

**NOTE**

A fuse and a thermistor are connected to each phase of  $U_a$ ,  $U_b$ , and  $U_c$  inside the power meter to prevent damage caused by external short circuits.  $U_a$ ,  $U_b$ , and  $U_c$  do not need to be protected by external fuses.

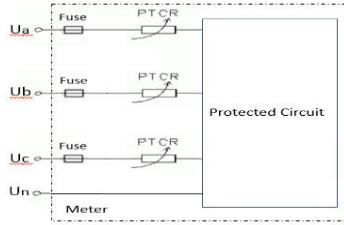
**Wiring Diagram--Three Phase Four Wire**

Support model:

- DTSU666-H
- DTSU666-H 250 A/50 mA

Operating voltage: 0.7–1.3  $U_n$

1. Three phase four wire:  
Connect the  $U_a$ ,  $U_b$ ,  $U_c$ ,  $U_n$  voltage lines to the 3, 6, 9 and 10 terminals of the collector. Connect current transformer outlets  $IA^*$ ,  $IA$ ,  $IB^*$ ,  $IB$ ,  $IC^*$ ,  $IC$  to terminals 13, 14, 16, 17, 19, 21 of the collector.
2. Connect RS485A and RS485B to the communication host.

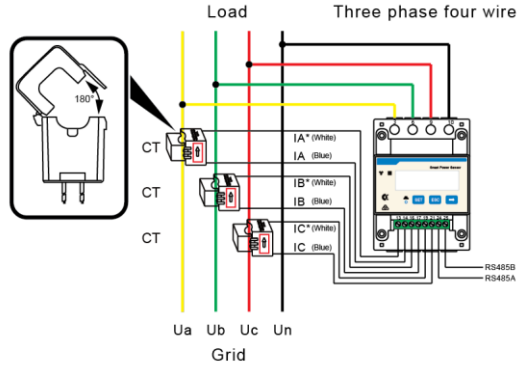
**NOTE**

The CT direction must be consistent with the arrow direction as shown in the preceding figure.

**Wiring Diagram--Three Phase Three Wire**

Support model:

- DTSU666-H 250 A/50 mA

Operating voltage: 0.7–1.3  $U_n$

1. Three phase three wire:  
Connect the  $U_a$ ,  $U_c$ ,  $U_b$  voltage lines to the 3, 9 and 10 terminals of the collector. Connect current transformer outlets  $IA^*$ ,  $IA$ ,  $IB^*$ ,  $IB$ ,  $IC^*$ ,  $IC$  to terminals 13, 14, 16, 17, 19, 21 of the collector.
2. Connect RS485A and RS485B to the communication host.

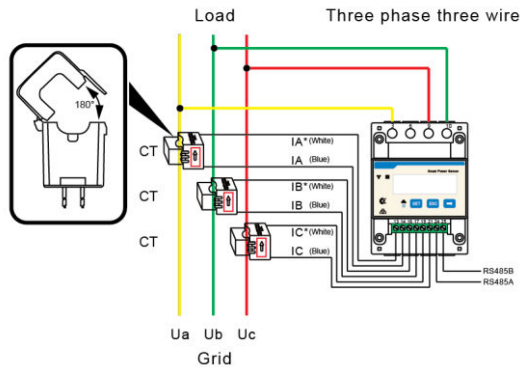





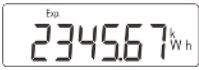

**NOTE**

The CT direction must be consistent with the arrow direction as shown in the preceding figure.











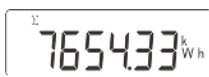

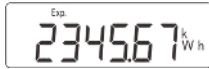
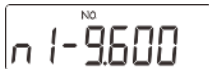
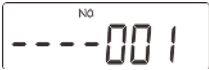

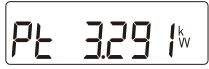

## 4 User Interface

### Display (Auto loop)

If no button is pressed for 60 seconds, the backlight turns off. Auto loop Switch time = 5s.

No.	Display interface	Description	No.	Display interface	Description
1		Imp. active energy = 10000.0 kWh	2		Exp. active energy = 2345.67 kWh
3		Active power = 3.291 kW	4		Phase A voltage = 220.0 V
5		Phase B voltage = 220.1 V	6		Phase C voltage = 220.20 V
7		Phase A current = 5.000 A	8		Phase B current = 5.001 A
9		Phase C current = 5.002 A	10		Frequency freq = 50.00 Hz

Display (Change by key "→")

No.	Display interface	Description	No.	Display interface	Description
1		Comb. active energy = 7654.33 kWh	2		Imp. active energy = 10000.0 kWh
3		Exp. active energy = 2345.67 kWh	4		None parity, 1 stop bit, Baud = 9600 bps
5		001 represents address	6		Phase A voltage = 220.0 V
7		Phase B voltage = 220.1 V	8		Phase C voltage = 220.20 V
9		Phase A current = 5.000 A	10		Phase B current = 5.001 A
11		Phase C current = 5.002 A	12		Phase active power = 3.291 kW
13		Phase A active power = 1.090 kW	14		Phase B active power = 1.101 kW
15		Phase C active power = 1.100 kW	16		Power factor PFt = 0.500 L
17		Phase A power factor Pfa = 1.000 L	18		Phase B power factor PFb = 0.500 L
19		Phase C power factor PFc = 0.500 C	20		Frequency freq = 50.00 Hz

Comb. active energy = Imp. active energy - Exp. active energy

## Parameter

Parameter	Value range	Description
<i>Prot</i>	1: 645; 2: n.2; 3: n.1; 4: E.1; 5: O.1;	Settings for communication stop bit and Parity bits: 1: Factory mode; 2: None parity, 2 stop bits, n.2; 3: None parity, 1 stop bit, n.1; 4: Even parity, 1 stop bit, E.1; 5: Odd parity, 1 stop bit, O.1;
<i>Addr</i>	0: 4.800; 1: 9.600;	Communication baud rate: 0: 4800 bps; 1: 9600 bps;
<i>bAud</i>	11–19	Communication address

## (Optional) Parameter Setup



### NOTE

Communications parameters have been configured for the power meter before delivery. If the communication is abnormal, check and set the parameters.

Button description: "SET" represents "confirm" or "cursor shift" (when entering digits), "ESC" represents "exit", and "→" represents "add". The password is **701** by default.

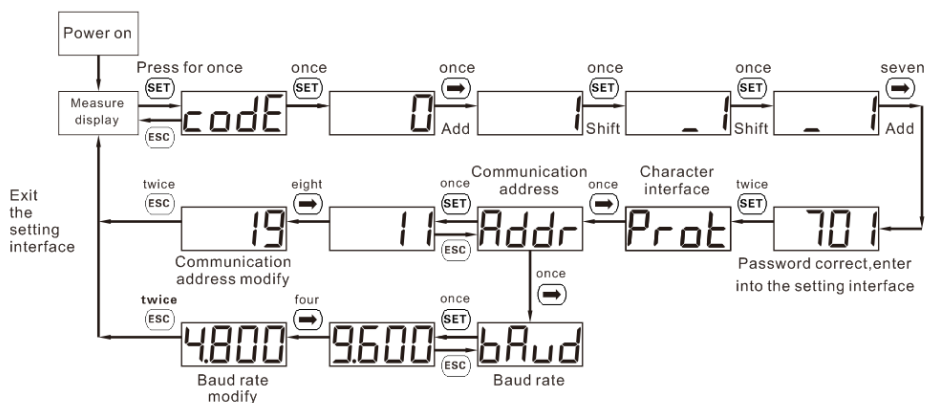

When modify digits, "SET" can be used as cursor shift button; "→" is "add" button; "ESC" represents exiting the setting interface or switch to the character interface from digit modification interface, restarting adding from zero after setting the digits to be the maximum value.



## 5 Troubleshooting

Fault phenomenon	Factor analysis	Elimination method
No display after the instrument being powered on	<ol style="list-style-type: none"><li>1. Incorrect wiring mode.</li><li>2. Abnormal voltage supplied for the instrument.</li></ol>	<ol style="list-style-type: none"><li>1. If the wiring mode is incorrect, please connect based on the correct wiring mode (see the <a href="#">wiring diagram</a>).</li><li>2. If the supplied voltage is abnormal, please supply the voltage on the instrument specification.</li></ol>
Abnormal RS485 communication	<ol style="list-style-type: none"><li>1. The RS485 communication cable is disconnected, short circuit or reversely connected.</li><li>2. The address, baud rate, data bit and parity bit of the instrument is not in accordance with the inverter.</li></ol>	<ol style="list-style-type: none"><li>1. If any problems for the communication cable, please change the cable.</li><li>2. Set the address, baud rate, data bit and parity bit of the instrument to be the same as the inverter through buttons and so as the "parameter setting".</li></ol>
Power metering inaccuracy	<ol style="list-style-type: none"><li>1. Wrong wiring, please check whether the corresponding phase sequence of voltage and current is correct.</li><li>2. Check whether the high and low ends of the current transformer inlet are reversely connected. Pa, Pb, and Pc are abnormal if the values are negative.</li></ol>	<ol style="list-style-type: none"><li>1. For wrong wiring, please connect based on the correct wiring mode (see the <a href="#">wiring diagram</a>).</li><li>2. If a negative value is displayed, change the cable connection mode of the current transformer to ensure that the high and low ends are connected properly.</li></ol>

## 6 Verifying the Installation

1. Check that all mounting brackets are securely installed and all screws are tightened.
2. Check that all cables are reliably connected with correct polarity and no short circuit.

## 7 Powering On the System

For details, see *DTSU666-H and DTSU666-H 250 A (50 mA) Smart Power Sensor User Manual*.

## 8 Customer Service Contact

Customer Service Contact			
Region	Country	Service Support Email	Phone
Europe	France	eu_inverter_support@huawei.com	0080033888888
	Germany		
	Spain		
	Italy		
	UK		
	Netherlands		
	Other countries		
Asia Pacific	Australia	au_inverter_support@huawei.com	1800046639
	Turkey	tr_inverter_support@huawei.com	-
	Malaysia	apsupport@huawei.com	0080021686868 /1800220036
	Thailand		(+66) 26542662 (charged by local call)
			1800290055 (free in Thailand)
	China	solarservice@huawei.com	4008229999
Other countries	apsupport@huawei.com	0060-3-21686868	
Japan	Japan	Japan_ESC@ms.huawei.com	0120258367
India	India	indiaenterprise_TAC@huawei.com	1800 103 8009
South Korea	South Korea	Japan_ESC@ms.huawei.com	-
North America	USA	na_inverter_support@huawei.com	1-877-948-2934
	Canada	na_inverter_support@huawei.com	1-855-482-9343
Latin America	Mexico	la_inverter_support@huawei.com	018007703456 /0052-442-4288288
	Argentina		0-8009993456
	Brazil		0-8005953456
	Chile		800201866 (only for fixed)
	Other countries		0052-442-4288288
Middle East and Africa	Egypt	mea_inverter_support@huawei.com	08002229000 /0020235353900
	UAE		08002229000
	South Africa		0800222900
	Saudi Arabia		8001161177
	Pakistan		0092512800019
	Morocco		0800009900
	Other countries		0020235353900

**Huawei Technologies Co., Ltd.**

Huawei Industrial Base, Bantian, Longgang,  
Shenzhen 518129, People's Republic of China  
[solar.huawei.com](http://solar.huawei.com)